



MORE[®] | 茂昌电子
CHANCE

CUSTOMER : STD
PRODUCTS : SMD POWER INDUCTOR
PART NO : MCSC Series
CUST P/ NO :
DATE : 2021.11.30
SALES DEP :
E-MAIL :

VERSION : REV.C
CHANGE PROJECT : -
BEFORE : -
AFTER : -
CHANGE DATE : -
CUSTOMER SIGNATURE : -

APPROVAL BY :	CHECK BY :	DRAWN BY :
<i>Honey Wei</i>	<i>Leo Wang</i>	<i>May Gao</i>



MORE[®] | 茂昌电子
CHANCE

Suzhou, Wuzhong District, Taihu East Road No.9, Wuluo science and Technology Park, 4th floor, 401/408 Room
Specifications subject to change without notice. Please confirm according to our company for latest information.

TEL : 0512-6856-2977
TEL : 0755-2738-9457

MCSC Series



- SMD POWER INDUCTOR
- Operating Temperature up to $-40\text{ }^{\circ}\text{C} \sim 125\text{ }^{\circ}\text{C}$
- High Current up to 8.5 A
- Low DCR down to 10 mOhms
 - Environmental Lead free
 - Environmental RoHS2.0 compliant
 - Environmental halogen free
- Storage Temperature : $-40\text{ }^{\circ}\text{C} \sim +85\text{ }^{\circ}\text{C}$
- Packaging 13"Reel, Plastic tape:12/16 mm wide

FEATURES

- Excellent soldeability and heat resistance.
- Excellent terminal strength.
- Packed in embossed carrier tape and can be used by automatic mounting machine.
- Available in various sizes.
- Easy to customized.

Applications

- Power supply for VCR, OA equipment, LCD TV,
- Notebook PC, DC/DC Converter, DC/AC Inverter.

PRODUCT IDENTIFICATION

MC SC 32 Z 1R0 M
 ① ② ③ ④ ⑤ ⑥

- ① Brand & Product classification
- ② Product Series NO.
- ③ External Dimensions.(32: L:3.0 × W:3.0 × H:2.0) [mm]
- ④ Separator code.
- ⑤ Inductance. (Exp. 1.0 uH = 1R0)

Example	Nominal Value
1R0	1.0uH
2R2	2.2uH
3R3	3.3uH
4R7	4.7uH

- ⑥ Inductance Tolerance.(L: $\pm 15\%$; M: $\pm 20\%$; N: $\pm 30\%$)

Mechanical & Dimensions

(Unit: mm)

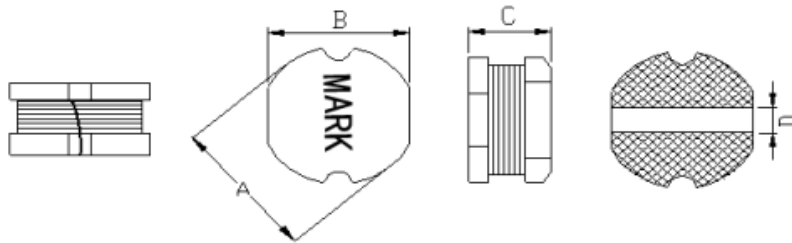

Code	Dimensions
A	3.5 ± 0.3
B	3.0 ± 0.3
C	2.1 ± 0.3
D	1.2 ± 0.3

Recommend Land Pattern Dimensions

(Unit: mm)

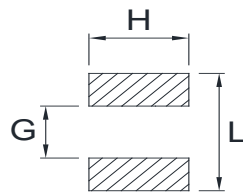

Code	Dimensions
L	4.0 Ref
H	3.4 Ref
G	0.9 Ref

Electrical Characteristics

Part Number	Inductance ¹ (μH)	DCR ² (mΩ) Max	I-sat ³ (Amps) Typ	Marking		
MCSC32Z1R0M	1.0±20%	40.0	3.34	1R0		
MCSC32Z1R2M	1.2±20%	50.0	2.60	1R2		
MCSC32Z1R5M	1.5±20%	60.0	2.40	1R5		
MCSC32Z1R8M	1.8±20%	70.0	2.35	1R8		
MCSC32Z2R2M	2.2±20%	75.0	2.35	2R2		
MCSC32Z2R7M	2.7±20%	100.0	1.90	2R7		
MCSC32Z3R3M	3.3±20%	110.0	1.80	3R3		
MCSC32Z4R7M	4.7±20%	135.0	1.30	4R7		
MCSC32Z5R6M	5.6±20%	200.0	1.20	5R6		
MCSC32Z6R8M	6.8±20%	210.0	1.15	6R8		
MCSC32Z100K	10.0±10%	320.0	1.10	100		
MCSC32Z120K	12.0±10%	360.0	0.85	120		
MCSC32Z150K	15.0±10%	460.0	0.80	150		
MCSC32Z220K	22.0±10%	650.0	0.65	220		
MCSC32Z270K	27.0±10%	780.0	0.50	270		
MCSC32Z330K	33.0±10%	800.0	0.50	330		
MCSC32Z430K	43.0±10%	1590.0	0.45	430		
MCSC32Z470K	47.0±10%	1600.0	0.45	470		
MCSC32Z560K	56.0±10%	1650.0	0.30	560		
MCSC32Z680K	68.0±10%	1800.0	0.29	680		

Note:

1. Inductance is measured at 100 KHz and 0.25 Vrms.
2. The nominal DCR is measured at 25°C ambient temperature.
3. The I-sat that will cause initial inductance value approximately 10% rolloff.

Mechanical & Dimensions

(Unit: mm)

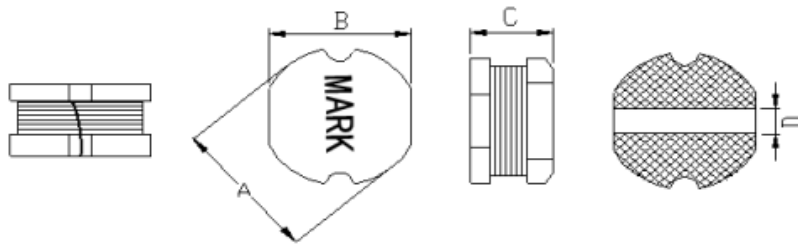

Code	Dimensions
A	3.5 ± 0.3
B	3.0 ± 0.3
C	2.1 ± 0.3
D	1.2 ± 0.3

Recommend Land Pattern Dimensions

(Unit: mm)

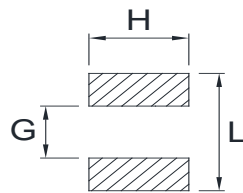

Code	Dimensions
L	4.0 Ref
H	3.4 Ref
G	0.9 Ref

Electrical Characteristics

Part Number	Inductance ¹ (μH)	DCR ² (mΩ) Max	I-sat ³ (Amps) Typ	Marking		
MCSC32Z101K	100±10%	2850	0.25	101		
MCSC32Z151K	150±10%	4200	0.16	151		
MCSC32Z221K	220±10%	6000	0.20	221		
MCSC32Z301K	300±10%	7000	0.10	301		
MCSC32Z331K	330±10%	9500	0.09	331		
MCSC32Z471M	470±20%	11480	0.15	471		
MCSC32Z681K	680±10%	20500	0.04	681		

Note:
 1. Inductance is measured at 100 KHz and 0.25 Vrms.
 2. The nominal DCR is measured at 25°C ambient temperature.
 3. The I-sat that will cause initial inductance value approximately 10% rolloff.

Mechanical & Dimensions

(Unit: mm)

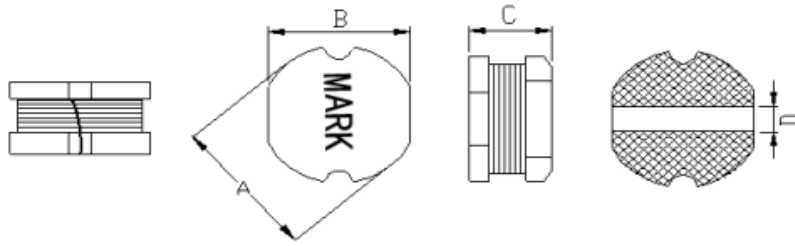

Code	Dimensions
A	4.5 ± 0.3
B	4.0 ± 0.3
C	3.2 ± 0.3
D	1.6 Ref

Recommend Land Pattern Dimensions

(Unit: mm)

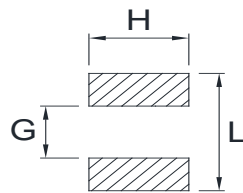

Code	Dimensions
L	5.0 Ref
H	4.5 Ref
G	1.3 Ref

Electrical Characteristics

Part Number	Inductance ¹ (μH)	DCR ² (mΩ) Max	I-sat ³ (Amps) Typ	Marking		
MCSC43Z1R0M	1.0 ± 20%	30.0	3.80	1R0		
MCSC43Z1R2M	1.2 ± 20%	36.0	3.50	1R2		
MCSC43Z1R4M	1.4 ± 20%	38.0	3.30	1R4		
MCSC43Z1R5M	1.5 ± 20%	38.0	3.00	1R5		
MCSC43Z1R8M	1.8 ± 20%	42.0	2.91	1R8		
MCSC43Z2R2M	2.2 ± 20%	48.0	3.00	2R2		
MCSC43Z2R7M	2.7 ± 20%	52.0	2.50	2R7		
MCSC43Z3R0M	3.0 ± 20%	55.0	2.50	3R0		
MCSC43Z3R3M	3.3 ± 20%	55.0	2.60	3R3		
MCSC43Z3R9M	3.9 ± 20%	76.0	1.98	3R9		
MCSC43Z4R7M	4.7 ± 20%	94.0	1.90	4R7		
MCSC43Z5R6M	5.6 ± 20%	100.0	1.80	5R6		
MCSC43Z6R8M	6.8 ± 20%	120.0	1.60	6R8		
MCSC43Z8R2M	8.2 ± 20%	132.0	1.26	8R2		
MCSC43Z100K	10.0± 10%	180.0	1.15	100		
MCSC43Z120K	12.0± 10%	210.0	1.05	120		
MCSC43Z150K	15.0± 10%	240.0	0.92	150		
MCSC43Z180K	18.0± 10%	338.0	0.84	180		
MCSC43Z220K	22.0± 10%	378.0	0.76	220		
MCSC43Z270K	27.0± 10%	410.0	0.71	270		

Note:

1. Inductance is measured at 100 KHz and 0.25 Vrms.
2. The nominal DCR is measured at 25°C ambient temperature.
3. The I-sat that will cause initial inductance value approximately 10% rolloff.

Mechanical & Dimensions

(Unit: mm)

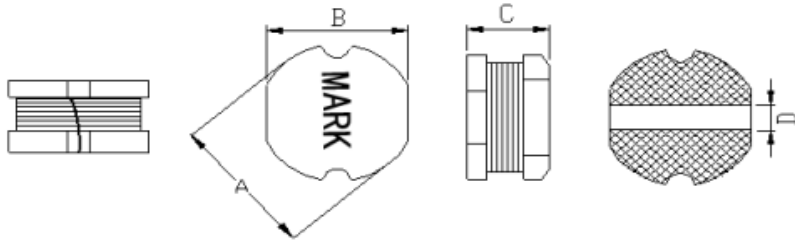

Code	Dimensions
A	4.5 ± 0.3
B	4.0 ± 0.3
C	3.2 ± 0.3
D	1.6 Ref

Recommend Land Pattern Dimensions

(Unit: mm)

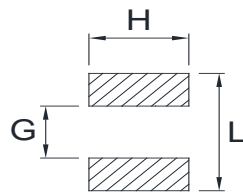

Code	Dimensions
L	5.0 Ref
H	4.5 Ref
G	1.3 Ref

Electrical Characteristics

Part Number	Inductance ¹ (μH)	DCR ² (mΩ) Max	I-sat ³ (Amps) Typ	Marking		
MCSC43Z330K	33.0± 10%	510	0.70	330		
MCSC43Z390K	39.0± 10%	560	0.66	390		
MCSC43Z470K	47.0± 10%	800	0.65	470		
MCSC43Z560K	56.0± 10%	960	0.50	560		
MCSC43Z680K	68.0± 10%	1117	0.46	680		
MCSC43Z820K	82.0± 10%	1345	0.45	820		
MCSC43Z101K	100±10%	1520	0.44	101		
MCSC43Z151K	150±10%	2000	0.42	151		
MCSC43Z221K	220±10%	3400	0.36	221		
MCSC43Z331K	330±10%	5300	0.28	331		
MCSC43Z471K	470±10%	6800	0.20	471		
MCSC43Z681K	680±10%	10000	0.18	681		
MCSC43Z102K	1000±10%	15600	0.14	102		

Note:
 1. Inductance is measured at 100 KHz and 0.25 Vrms.
 2. The nominal DCR is measured at 25°C ambient temperature.
 3. The I-sat that will cause initial inductance value approximately 10% rolloff.

Mechanical & Dimensions

(Unit: mm)

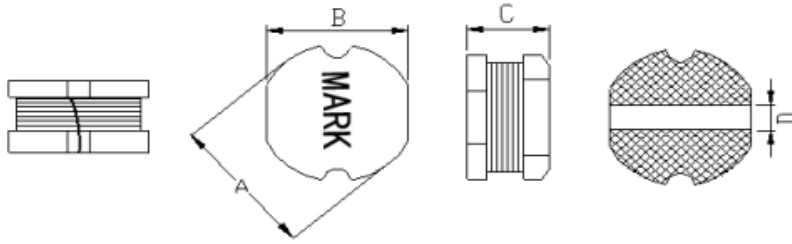

Code	Dimensions
A	5.8 ± 0.3
B	5.2 ± 0.3
C	3.0 ± 0.3
D	2.0 Ref

Recommend Land Pattern Dimensions

(Unit: mm)

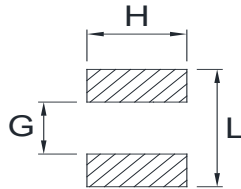

Code	Dimensions
L	6.5 Ref
H	5.5 Ref
G	1.7 Ref

Electrical Characteristics

Part Number	Inductance ¹ (μH)	DCR ² (mΩ) Max	I-sat ³ (Amps) Typ	Marking		
MCSC53Z1R0M	1.0 ± 20%	30.0	4.50	1R0		
MCSC53Z1R2M	1.2 ± 20%	25.0	4.60	1R2		
MCSC53Z1R5M	1.5 ± 20%	30.0	4.10	1R5		
MCSC53Z2R2M	2.2 ± 20%	35.0	3.50	2R2		
MCSC53Z2R7M	2.7 ± 20%	40.0	3.20	2R7		
MCSC53Z3R3M	3.3 ± 20%	50.0	3.00	3R3		
MCSC53Z3R9M	3.9 ± 20%	60.0	2.60	3R9		
MCSC53Z4R7M	4.7 ± 20%	70.0	2.50	4R7		
MCSC53Z5R6M	5.6 ± 20%	80.0	2.40	5R6		
MCSC53Z6R8M	6.8 ± 20%	90.0	2.20	6R8		
MCSC53Z8R2M	8.2 ± 20%	100.0	2.00	8R2		
MCSC53Z100K	10.0± 10%	120.0	1.80	100		
MCSC53Z150K	15.0± 10%	150.0	1.70	150		
MCSC53Z180K	18.0± 10%	232.0	1.60	180		
MCSC53Z220K	22.0± 10%	220.0	1.50	220		
MCSC53Z270K	27.0± 10%	260.0	1.20	270		
MCSC53Z330K	33.0± 10%	330.0	1.10	330		
MCSC53Z390K	39.0± 10%	400.0	1.00	390		
MCSC53Z470K	47.0± 10%	430.0	0.90	470		
MCSC53Z680K	68.0± 10%	600.0	0.75	680		

Note:

1. Inductance is measured at 100 KHz and 0.25 Vrms.
2. The nominal DCR is measured at 25°C ambient temperature.
3. The I-sat that will cause initial inductance value approximately 10% rolloff.

Mechanical & Dimensions

(Unit: mm)

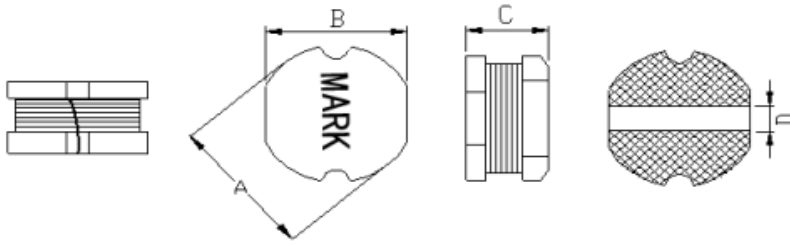

Code	Dimensions
A	5.8 ± 0.3
B	5.2 ± 0.3
C	3.0 ± 0.3
D	2.0 Ref

Recommend Land Pattern Dimensions

(Unit: mm)

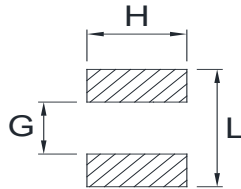

Code	Dimensions
L	6.5 Ref
H	5.5 Ref
G	1.7 Ref

Electrical Characteristics

Part Number	Inductance ¹ (μH)	DCR ² (mΩ) Max	I-sat ³ (Amps) Typ	Marking		
MCSC53Z820K	82.0± 10%	820	0.65	820		
MCSC53Z101K	100±10%	900	0.60	101		
MCSC53Z121K	120±10%	1000	0.58	121		
MCSC53Z151K	150±10%	1560	0.53	151		
MCSC53Z221K	220±10%	2000	0.38	221		
MCSC53Z331K	330±10%	4000	0.35	331		
MCSC53Z391K	390±10%	4100	0.32	391		
MCSC53Z451K	450±10%	4200	0.30	451		
MCSC53Z471K	470±10%	4300	0.20	471		
MCSC53Z681K	680±10%	7000	0.18	681		
MCSC53Z102K	1000±10%	8000	0.13	102		

Note:
 1. Inductance is measured at 100 KHz and 0.25 Vrms.
 2. The nominal DCR is measured at 25°C ambient temperature.
 3. The I-sat that will cause initial inductance value approximately 10% rolloff.

Mechanical & Dimensions

(Unit: mm)

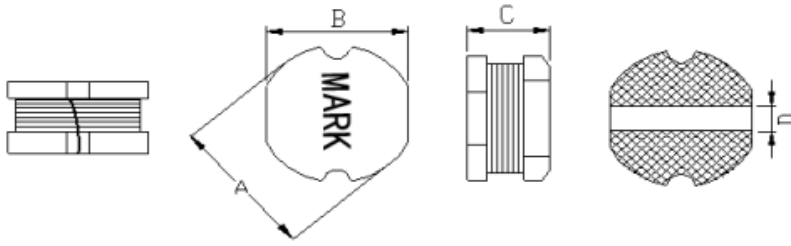

Code	Dimensions
A	5.8 ± 0.3
B	5.2 ± 0.3
C	4.5 ± 0.3
D	2.0 Ref

Recommend Land Pattern Dimensions

(Unit: mm)

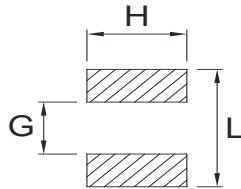

Code	Dimensions
L	6.5 Ref
H	5.5 Ref
G	1.7 Ref

Electrical Characteristics

Part Number	Inductance ¹ (μH)	DCR ² (mΩ) Max	I-sat ³ (Amps) Typ	Marking
MCSC54Z1R0M	1.0 ±20%	15.0	5.90	1R0
MCSC54Z1R2M	1.2 ±20%	16.0	5.30	1R2
MCSC54Z1R5M	1.5 ±20%	20.0	5.30	1R5
MCSC54Z2R2M	2.2 ±20%	26.0	4.60	2R2
MCSC54Z2R7M	2.7 ±20%	28.0	4.40	2R7
MCSC54Z3R3M	3.3 ±20%	34.0	4.30	3R3
MCSC54Z3R9M	3.9 ±20%	37.0	4.10	3R9
MCSC54Z4R7M	4.7 ±20%	40.0	4.00	4R7
MCSC54Z6R8M	6.8 ±20%	60.0	3.00	6R8
MCSC54Z100K	10.0 ±10%	75.0	2.00	100
MCSC54Z120K	12.0 ±10%	100.0	1.60	120
MCSC54Z150K	15.0 ±10%	120.0	1.55	150
MCSC54Z180K	18.0 ±10%	150.0	1.55	180
MCSC54Z220K	22.0 ±10%	170.0	1.50	220
MCSC54Z330K	33.0 ±10%	230.0	0.88	330
MCSC54Z470K	47.0 ±10%	350.0	0.85	470
MCSC54Z680K	68.0 ±10%	460.0	0.61	680
MCSC54Z820K	82.0 ±10%	600.0	0.58	820
MCSC54Z101K	100 ±10%	700.0	0.55	101
MCSC54Z121K	120 ±10%	770.0	0.55	121

Note:

1. Inductance is measured at 100 KHz and 0.25 Vrms.
2. The nominal DCR is measured at 25°C ambient temperature.
3. The I-sat that will cause initial inductance value approximately 10% rolloff.

Mechanical & Dimensions (Unit: mm)

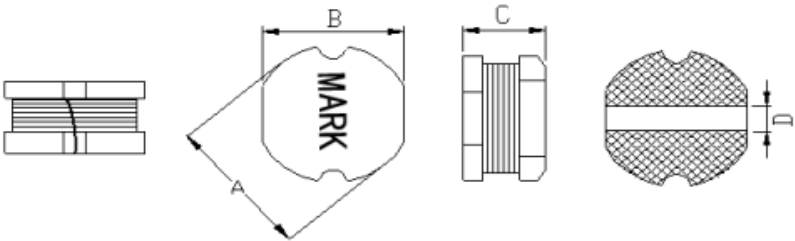
	Code	Dimensions
	A	5.8 ± 0.3
	B	5.2 ± 0.3
	C	4.5 ± 0.3
	D	2.0 Ref

Recommend Land Pattern Dimensions (Unit: mm)

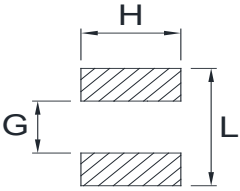
	Code	Dimensions
	L	6.5 Ref
	H	5.5 Ref
	G	1.7 Ref

Electrical Characteristics

Part Number	Inductance ¹ (μ H)	DCR ² (m Ω) Max	I-sat ³ (Amps) Typ	Marking		
MCSC54Z151K	150 \pm 10%	1200	0.52	151		
MCSC54Z221K	220 \pm 10%	1650	0.50	221		
MCSC54Z331K	330 \pm 10%	1800	0.28	331		
MCSC54Z471K	470 \pm 10%	3000	0.25	471		
MCSC54Z681K	680 \pm 10%	5100	0.25	681		
MCSC54Z821K	820 \pm 10%	5300	0.22	821		
MCSC54Z102K	1000 \pm 10%	7000	0.10	102		

Note:

- Inductance is measured at 100 KHz and 0.25 Vrms.
- The nominal DCR is measured at 25°C ambient temperature.
- The I-sat that will cause initial inductance value approximately 10% rolloff.

Mechanical & Dimensions

(Unit: mm)

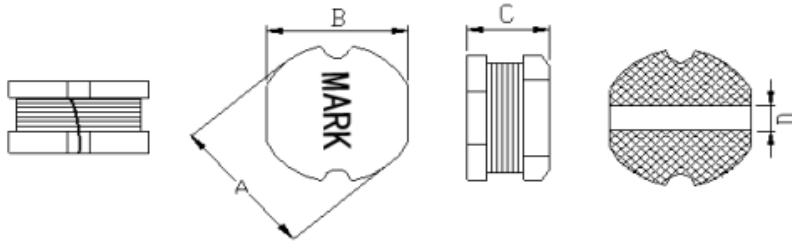

Code	Dimensions
A	7.8 ± 0.3
B	7.0 ± 0.3
C	5.0 ± 0.3
D	2.5 Ref

Recommend Land Pattern Dimensions

(Unit: mm)

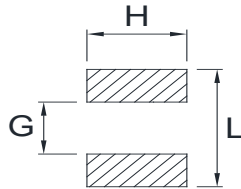

Code	Dimensions
L	9.2 Ref
H	7.5 Ref
G	2.2 Ref

Electrical Characteristics

Part Number	Inductance ¹ (μH)	DCR ² (mΩ) Max	I-sat ³ (Amps) Typ	Marking		
MCSC75Z1R0M	1.0 ± 20%	10.0	8.50	1R0		
MCSC75Z1R5M	1.5 ± 20%	18.0	5.20	1R2		
MCSC75Z2R2M	2.2 ± 20%	20.0	5.00	2R2		
MCSC75Z3R3M	3.3 ± 20%	30.0	3.90	3R3		
MCSC75Z4R7M	4.7 ± 20%	35.0	3.80	4R7		
MCSC75Z5R6M	5.6 ± 20%	40.0	3.20	5R6		
MCSC75Z6R8M	6.8 ± 20%	45.0	3.10	6R8		
MCSC75Z8R2M	8.2 ± 20%	50.0	2.80	8R2		
MCSC75Z100K	10.0 ± 10%	50.0	2.60	100		
MCSC75Z120K	12.0 ± 10%	70.0	2.10	120		
MCSC75Z150K	15.0 ± 10%	80.0	2.00	150		
MCSC75Z180K	18.0 ± 10%	100.0	1.60	180		
MCSC75Z220K	22.0 ± 10%	110.0	1.50	220		
MCSC75Z270K	27.0 ± 10%	120.0	1.30	270		
MCSC75Z330K	33.0 ± 10%	130.0	1.20	330		
MCSC75Z390K	39.0 ± 10%	160.0	1.10	390		
MCSC75Z470K	47.0 ± 10%	180.0	1.10	470		
MCSC75Z560K	56.0 ± 10%	240.0	0.94	560		
MCSC75Z680K	68.0 ± 10%	280.0	0.85	680		
MCSC75Z820K	82.0 ± 10%	360.0	0.78	820		

Note:

1. Inductance is measured at 100 KHz and 0.25 Vrms.
2. The nominal DCR is measured at 25°C ambient temperature.
3. The I-sat that will cause initial inductance value approximately 10% rolloff.

Mechanical & Dimensions

(Unit: mm)

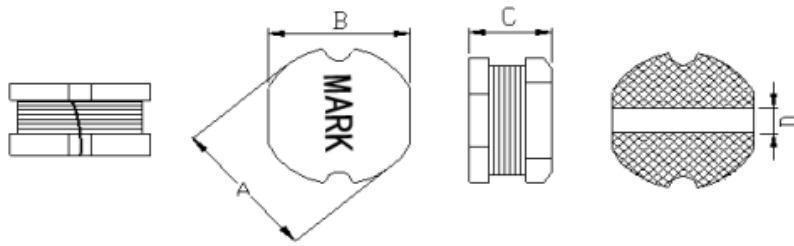

Code	Dimensions
A	7.8 ± 0.3
B	7.0 ± 0.3
C	5.0 ± 0.3
D	2.5 Ref

Recommend Land Pattern Dimensions

(Unit: mm)

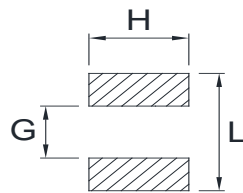

Code	Dimensions
L	9.2 Ref
H	7.5 Ref
G	2.2 Ref

Electrical Characteristics

Part Number	Inductance ¹ (μH)	DCR ² (mΩ) Max	I-sat ³ (Amps) Typ	Marking		
MCSC75Z101K	100 ±10%	370.0	0.72	101		
MCSC75Z121K	120 ±10%	470.0	0.66	121		
MCSC75Z151K	150 ±10%	640.0	0.58	151		
MCSC75Z181K	180 ±10%	710.0	0.51	181		
MCSC75Z221K	220 ±10%	780.0	0.49	221		
MCSC75Z301K	300 ±10%	1100	0.40	301		
MCSC75Z331K	330 ±10%	1260	0.40	331		
MCSC75Z471K	470 ±10%	1890	0.35	471		
MCSC75Z561K	560 ±10%	2000	0.33	561		
MCSC75Z681K	680 ±10%	2560	0.31	681		
MCSC75Z821K	820 ±10%	3250	0.30	821		
MCSC75Z102K	1000 ±10%	3300	0.30	102		
MCSC75Z222K	2200 ±10%	6800	0.18	222		
MCSC75Z103K	10000 ±10%	44.1Ω	0.09	103		

Note:
 1. Inductance is measured at 100 KHz and 0.25 Vrms.
 2. The nominal DCR is measured at 25°C ambient temperature.
 3. The I-sat that will cause initial inductance value approximately 10% rolloff.

Packaging

Reel Dimension:

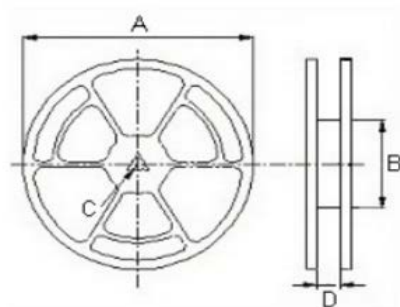

P/N	Type	A(mm)	B(mm)	C(mm)	D(mm)	Chip/Reel
MCSC32Z Series	13" x 12mm	330	20	13	12.5	3,000
MCSC43Z Series	13" x 12mm	330	20	13	12.5	2,000
MCSC53Z Series	13" x 12mm	330	20	13	12.5	2,000
MCSC54Z Series	13" x 12mm	330	20	13	12.5	1,500
MCSC75Z Series	13" x 16mm	330	20	13	16.5	1,000

Packaging

Tape Dimension:

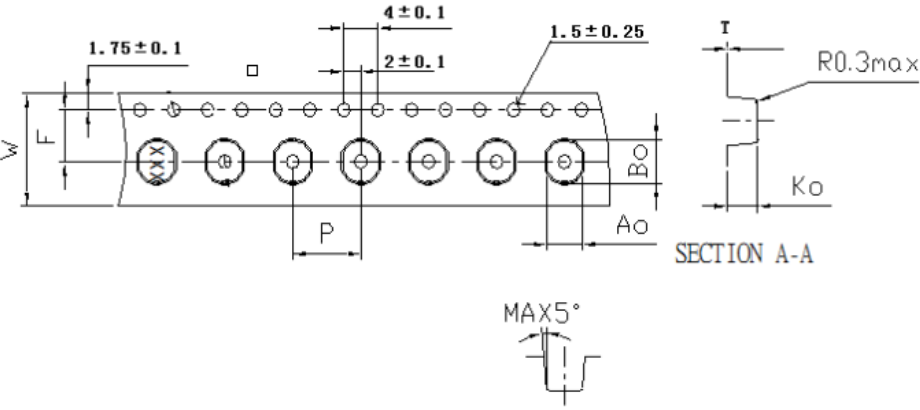

P/N	Ao(mm)	Bo(mm)	Ko(mm)	F(mm)	P(mm)	T(mm)	W(mm)		
MCSC32Z Series	3.3	3.8	2.4	5.5	8	0.4	12		
MCSC43Z Series	4.3	4.8	3.6	5.5	8	0.4	12		
MCSC53Z Series	5.6	6.2	3.6	5.5	8	0.4	12		
MCSC54Z Series	5.6	6.2	4.9	5.5	8	0.4	12		
MCSC75Z Series	7.4	8.2	5.5	7.5	12	0.4	16		

Packaging

Tearing Off Force:

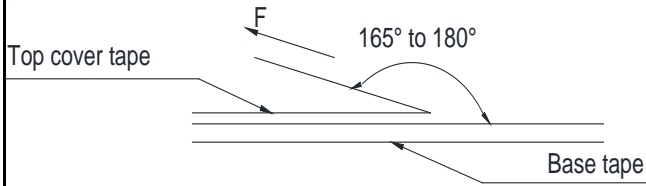

The force tearing off cobe tape is 10 to 130 g.f			
in the arrow direction under the following conditions			
Room Temp (°C)	Room Humidity (%)	Room atrn (hPa)	Teaming Speed (mm/min)
5~35	45~85	860~1060	300

※Storage Conditions

1. Temperature and humidity conditions:
-40°C ~ +85°C and 70% RH.
2. Recommended products should be used within 6 months form the time of delivery.
3. The packaging material should be kept where no chlorine or sulfur exists in the air.

※Transportation

1. Products should be handled with care to avoid damage or contamination from perspiration and skin oils.
2. The use of tweezers or vacuum pick up is strongly recommended for individual components.
3. Bulk handling should ensure that abrasion and mechanical shock are minimized.

Recommended Soldering Conditions

Figure 1. Re-flow Soldering

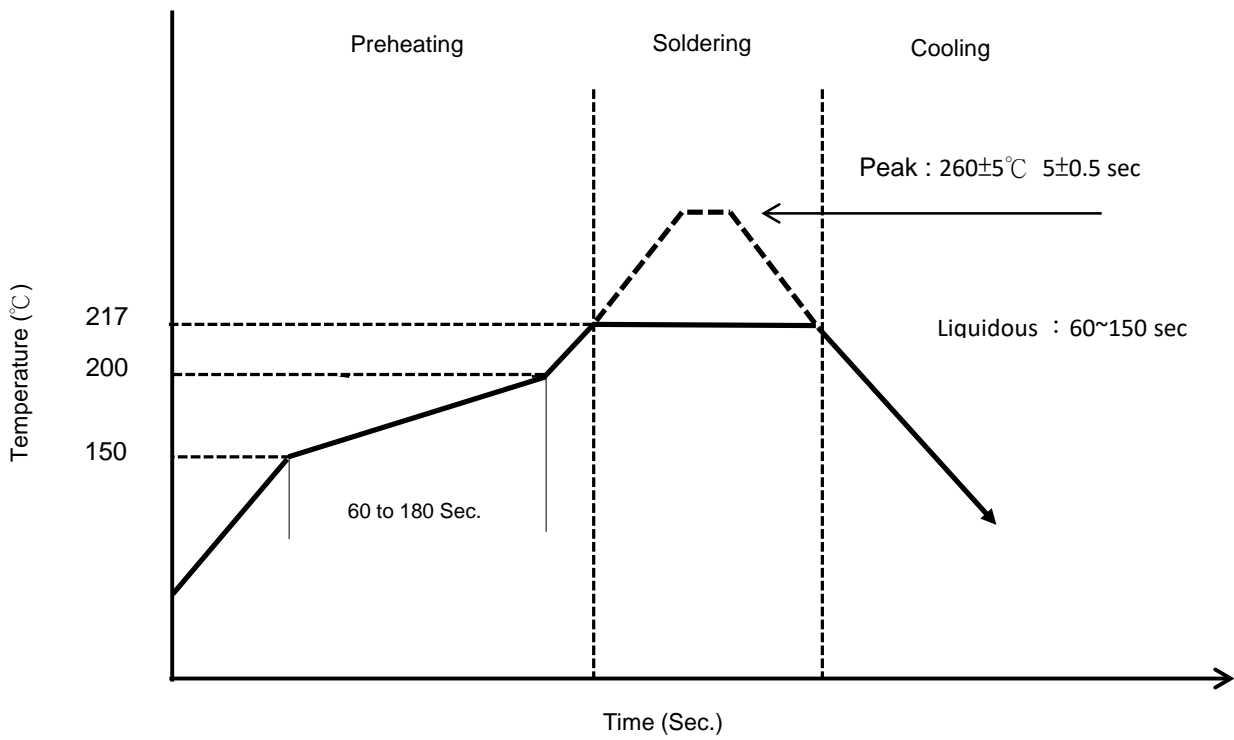
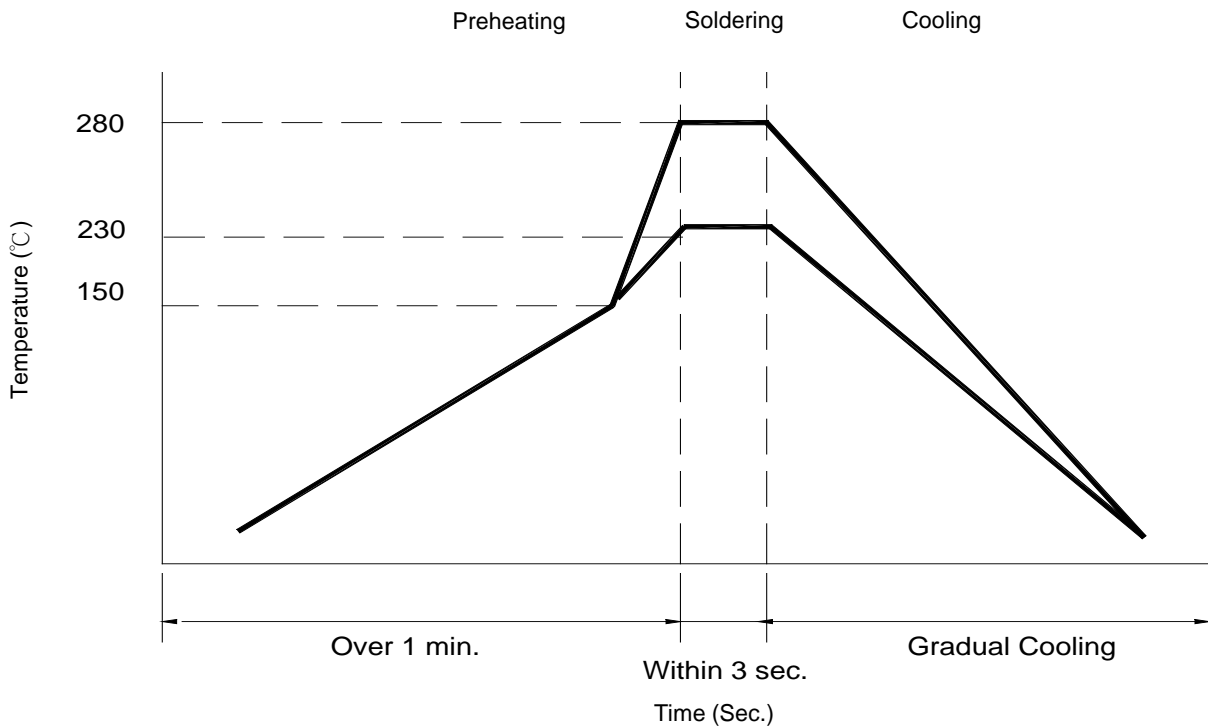
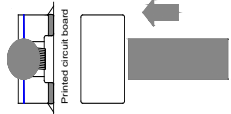

Figure 2. Hand Soldering



Reliability and Testing Conditions

Item	Specification	Conditions															
Operating temperature range	-40°C ~ +125°C (Including self-temperature rise)																
Storage temperature and humidity range	-40°C ~ +85°C , 70% RH Max																
Solderability	More than 90% of the terminal electrode should be covered with solder.	<ul style="list-style-type: none"> - Preheat: 150 °C , 60 sec - Solder: Sn96.5%-Ag3%-Cu0.5% - Temperature: 245±5°C - Flux for lead free: Rosin 9.5% - Dip time: 4±1 sec - Depth: completely cover the termination 															
Resistance to Soldering Heat	Inductance within ±20% of initial value. No disconnection or short circuit. The appearance shall not break.	<ul style="list-style-type: none"> - Solder technique simulation: SMD - Temperature (°C): 260 ± 3 (solder temp) - Time (s): 10 ± 1 - Temperature ramp / immersion and emersion rate: 25 mm/s ± 6 mm/s - Number of heat cycles: 1 															
Resistance to High Temperature	Inductance within ±20% of initial value. No disconnection or short circuit. The appearance shall not break.	500 hrs. at 125°C±3°C Unpowered. Measurement at 24±4 hours after test conclusion.															
Resistance to Low Temperature	Inductance within ±20% of initial value. No disconnection or short circuit. The appearance shall not break.	500 hrs. at -40°C±2°C. Unpowered. Measurement at 24±4 hours after test conclusion.															
Resistance to Humidity	Inductance within ±20% of initial value. No disconnection or short circuit. The appearance shall not break.	After 500 hours in 40±2°C and 90 to 95% humidity , and 2 hour drying under normal condition.															
Thermal shock	Inductance within ±20% of initial value. No disconnection or short circuit. The appearance shall not break.	<p style="text-align: center;">After 30 cycles of following condition.</p> <table border="1" style="margin-left: auto; margin-right: auto; border-collapse: collapse;"> <thead> <tr> <th>Step</th> <th>Temperature (°C)</th> <th>Times (min.)</th> </tr> </thead> <tbody> <tr> <td style="text-align: center;">1</td> <td style="text-align: center;">-40±2°C</td> <td style="text-align: center;">30</td> </tr> <tr> <td style="text-align: center;">2</td> <td style="text-align: center;">Room Temperature</td> <td style="text-align: center;">Within 3</td> </tr> <tr> <td style="text-align: center;">3</td> <td style="text-align: center;">125±3°C</td> <td style="text-align: center;">30</td> </tr> <tr> <td style="text-align: center;">4</td> <td style="text-align: center;">Room Temperature</td> <td style="text-align: center;">Within 3</td> </tr> </tbody> </table>	Step	Temperature (°C)	Times (min.)	1	-40±2°C	30	2	Room Temperature	Within 3	3	125±3°C	30	4	Room Temperature	Within 3
Step	Temperature (°C)	Times (min.)															
1	-40±2°C	30															
2	Room Temperature	Within 3															
3	125±3°C	30															
4	Room Temperature	Within 3															
Vibration Test	Inductance within ±10% of initial value and appearance shall not break.	After vibration for 1hour, In each of three orientations at sweep vibration (10~55~10Hz) with 1.52mm P-P Amplitudes.															
Terminal strength	The terminal electrode and the ferrite must not be damaged	Solder a chip to test substrate, and then laterally apply a load 10N in the arrow direction, Duration :5s 															
Drop Test	Inductance within ±10% of initial value. The appearance shall not break.	Drop 3 times on a concrete floor from a height of 75cm by inimum packing															